

DECRASOUND ACOUSTIC MATERIALS AND SOLUTIONS





Specialized in production of
acoustic materials and
providing acoustical solutions

CONTENT

POLYESTER FIBRE ACOUSTIC PANEL	01-05
POLYESTER FIBRE ACOUSTIC PANEL	02
POLYESTER FIBRE ACOUSTIC PANEL Colours	03-05
POLYESTER FIBRE ACOUSTIC INSULATION	06
POLYESTER FIBRE ACOUSTIC FABRIC WRAPPED PANEL	07
POLYESTER FIBRE ACOUSTIC FELT	08
POLYESTER FIBRE ACOUSTIC FELT PANEL COMPOSITION	09
CARVED FEATURED ACOUSTIC PANEL	10-16
HOLLOW-OUT PANEL	11-12
V-GROOVED PANEL	13-14
3D VISUAL U-GROOVED ACOUSTIC PANEL	15
Tear Drop ACOUSTIC WALL PANEL	16
PRINTED POLYESTER FIBRE ACOUSTIC PANEL	17
3D POLYESTER FIBRE ACOUSTIC	18-19
ACOUSTIC OFFICE FURNITURE	20-23
DESK DIVIDER	21
GIRANDO DIVIDER	22
Free STANDING DIVIDER	23
DECRASOUND APPLICATION	24-33
DECRAWAVES ACOUSTIC PANEL	25
DECRASLATS ACOUSTIC PANEL	26-27
DECRAWALL ACOUSTIC WALL	28
CEILING SYSTEM U TECHCEILING	29
CEILING SYSTEM DECRATUBE	30
CEILING SYSTEM DECRASTAR	31-32
CEILING SYSTEM DECRABAFFLE	33

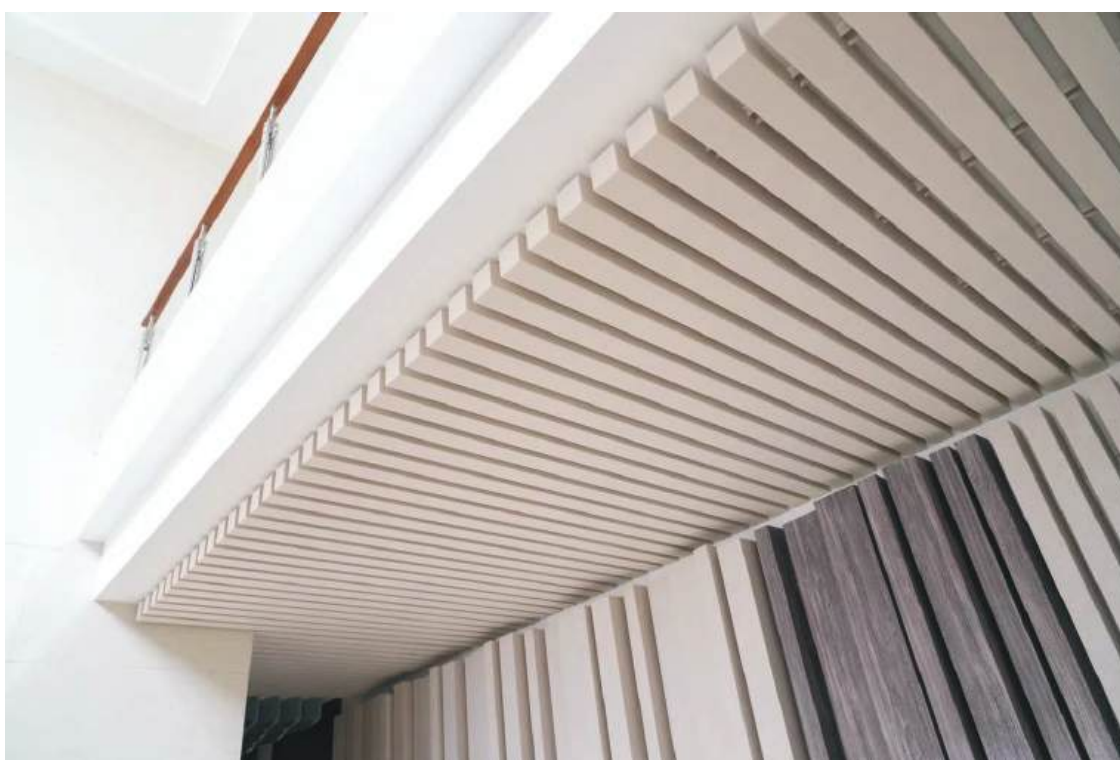

Polyester Fibre Acoustic Panels

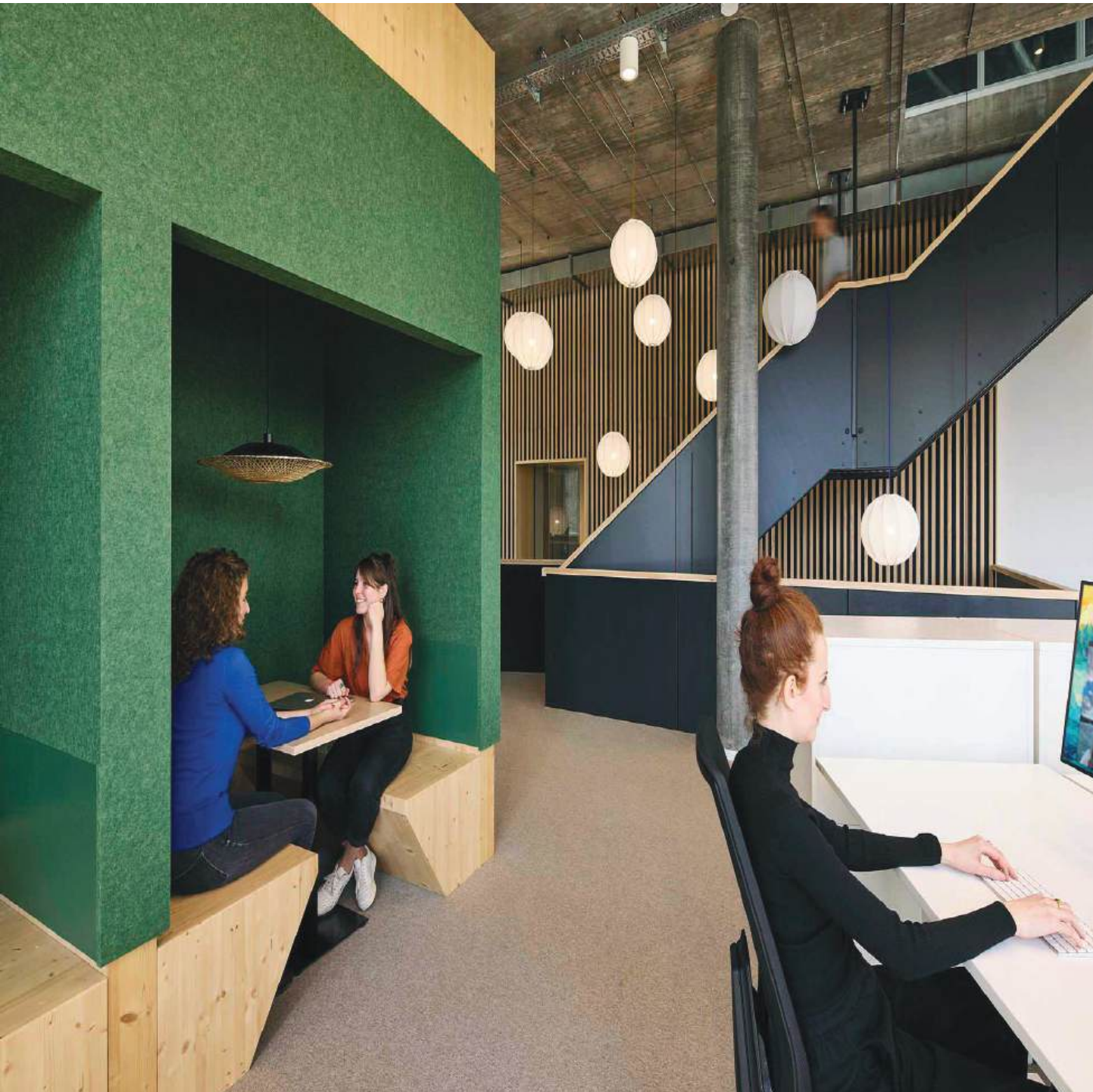

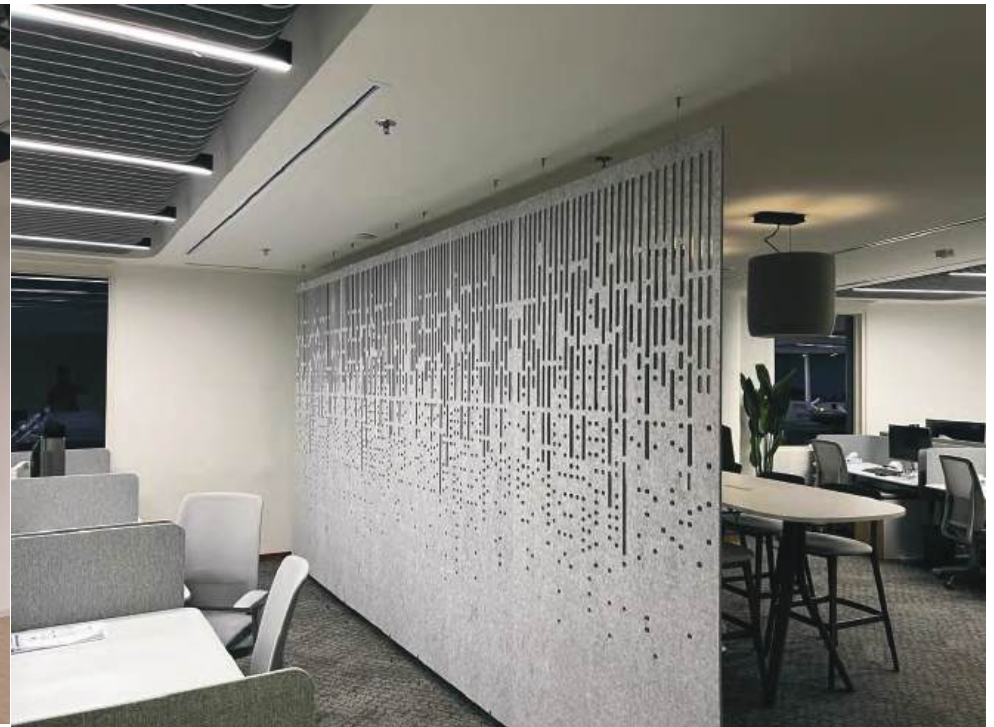

Product Specifications

Product	Polyester Fibre Acoustic Panel		
Material	100% polyester fiber		
Thickness (mm)	9	12	24
Density (g/sqm)	2000	2400	3800
Size A (m)	1.22*2.44	1.22*2.44	1.22*2.44
Size B (m)		1.22*2.80	1.22*2.80
Color	96 colors		
NRC	0.45-0.9		
Eco-friendly	E0		

POLYESTER FIBRE ACOUSTIC PANEL

DECRASOUND acoustic solutions are manufactured from Acoustiscreen polyester fibre acoustic panels. Acoustiscreen Polyester P.E.T. is made from 100% polyester fibre incorporating up to 75% post-consumer recycled material from P.E.T. bottles. Decrasound acoustic solutions maximize the reduction of internal unwanted noise. DECRASOUND remains at the forefront of delivering innovative acoustic solutions tailored for today's modern workplaces.

PRODUCT CHARACTERISTICS



ACOUSTIC



RECYCLE



PRINTABLE



TACKABLE



THERMAL INSULATION



VENTILATE



LIGHT WEIGHT



DECORATIVE



FIRE-RATED



IMPACT RESISTANCE



EASY INSTALLATION



NON TOXIN

96 Colors in stock

All colors 9mm and 12mm in stock, NO MOQ.

DECRASOUND develop 10 to 20 colors every year based on the international fashionable trends.

*24mm In Stock



DS-04 Pure White



DS-44 Creamy White



DS-07 Opera



DS-52 Rust



DS-17 Apple Red



DS-18 Tomato Puree



DS-34 Blackish Green



DS-22 Little Boy Blue



DS-06 Dark Camel



DS-01 Light Yellow



DS-43 Illuminating



DS-29 Gray Green



DS-31 Acros



DS_13 Greenery



DS-23 Beaucoup Blue



DS-47 Navy Peony



DS-02 Citrus



DS-49 Senado



DS-50 Iceland Poppy



DS-14 Flash Green



DS-32 Kelp Forest



DS_15 Lotus



DS-42 Forever



DS-35 Lue Curacao



DS-03 Orange Tiger



DS-51 Milk Cocoa



DS-46 Peach Pearl



DS-53 Abundant



DS-42 Blue Green



DS-40 Turquoise

























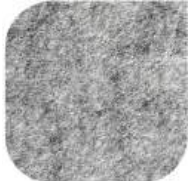









DS-21 Navagio Bay



DS-54 River side



*24mm In Stock

							
DS-33 Regatta	DS-16 Pageant Blue	DS-19 Purple	DS-48 Violet	DS-10 Silver Grey	DS-26 Sesame	DS-36 Dark Silver	DS-62 Ceylon
							
DS-37 Bonnie Blue	DS-30 Brown	DS-08 Red Coffee	DS-09 Light Grey	DS-38 Morandi	DS-45 Space Grey	DS-05 Light Camel	DS-06 Agarwood
							
DS-41 Falling Water	DS-39 Harbor	DS-12 Moon Grey	DS-25 Ultimate Grey	DS-28 Dark Grey	DS-56 Mountains Red	DS-57 Strom	DS-69 Ultimate Red
							
DS-20 Pagoda	DS-27 Pure Black	DS-11 Water Grey	DS-55 Sharp	DS-58 Matcha	DS-59 Zara Camel	DS-60 Pure Red	DS-72 Canary



*24mm In Stock



DS-63 Sky Blue



DS-65 Gem



DS-75 Golden



DS-76 Montana Grape



DS-77 Mulberry



DS-61 Black Green



DS-64 Sargazo



DS-81 Banana Yellow



DS-67 Perfectly Pale



DS-68 Grass Green



DS-78 Slate Grey



DS-79 Myst



DS-80 Neutral Grey

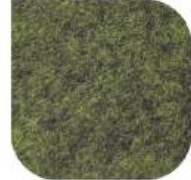

DS-88 Formal Garden



DS-89 Douglas Fir



DS-90 Brittany



DS-70 Fire Place



DS-71 Fairway



DS-82 Cadet



DS-83 Balsam



DS-84 Orion



DS-91 Bronze



DS-92 Pinnacle



DS-93 Winter Bloom



DS-73 Cloudburst



DS-74 Platinum



DS-85 Parthenon



DS-86 Highland



DS-87 Nerolac Terrace



DS-94 Corsair



DS-95 Cloisonne



DS-96 Enamel

Polyester Fibre Acoustic Insulation



Product Specifications

Product Type	Polyester Fibre acoustic insulation								
Material	100 % Polyester Fibre								
Size (m)	1*20	1*20	1*15	1*20	1.2*2.4	1.2*2.4	1.2*2.4	1.2*2.4	1.2*2.4
Thickness (mm)	50	30	80	50	50	25	50	50	50
Density (g/sqm)	400	300	640	400	1000	1000	2450	1000	2450
Fire Resistance	-	-	-	●	-	-	-	●	●
NRC	0.8-0.9								
Eco-friendly	E0								
Color	White, Black, Gray								



POLYESTER FIBRE ACOUSTIC FABRIC WRAPPED PANEL



When installed on walls and ceilings, DECRA SOUND fabric-wrapped panels transform them into practical sound barriers, significantly reducing noise and echoes. Made from a core of polyester fibre acoustic panels and covered with an acoustically transparent fabric, these panels come in various sizes, shapes, and colours to fit any decor, making them a perfect choice for improving any room's design and comfort.

Product Specifications

Product Type	Acoustic fabric wrapped panels
Material	100% Polyester Fibre
Size	up to 2780*1200mm
Thickness	10mm /13mm /25mm
Density	2000g/sqm ; 2400g/sqm ; 3800g/sqm
Color	42 colors
NRC	0.45-0.9

Fabric Wrapped Color Chart

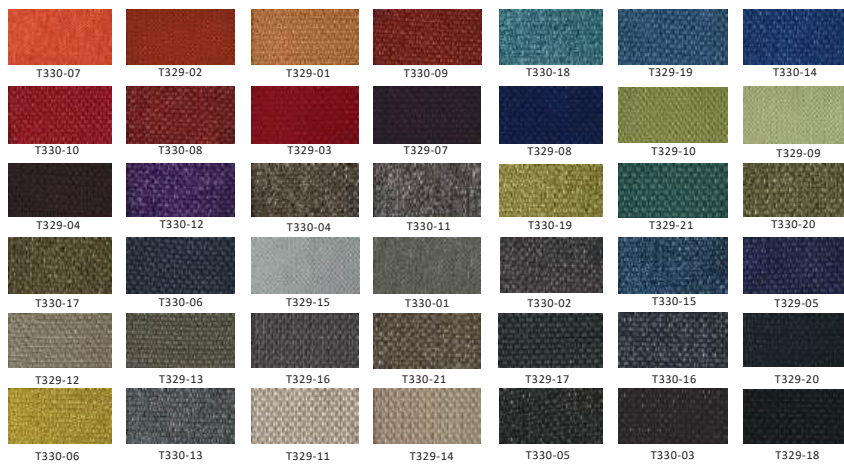

More Functions

Enhanced Acoustic Quality

Acoustic fabric-wrapped panels are designed to absorb sound waves, preventing them from reflecting off hard surfaces. This significantly reduces echoes for more precise communication and a quieter atmosphere. Ideal for conference rooms, home theatres, or open office spaces, these panels improve acoustic comfort across various settings.

Aesthetic Flexibility

One key advantage of Fabric-covered acoustic panels is their versatility in design. These panels are designed to integrate smoothly with any existing décor. They come in a broad range of fabric colours and patterns, allowing you to tailor them to suit the current aesthetic design of your space. This customization capability ensures that the acoustic improvements do not compromise the style or feel of your environment.

Adaptable and Versatile

Our acoustic panels are available in a range of shapes and sizes, from standard rectangles to custom designs, offering you the perfect fit for any space. This variety means you can precisely target and improve the acoustics where it matters most. Whether you want to mount them on walls, hang them from ceilings, or even incorporate them into furniture, these panels provide flexible solutions to meet your needs.

Health and Comfort

Too much noise can cause stress, tire you out, and make concentrating hard. Installing acoustic panels allows you to create a quieter, more comfortable space to live or work in. Less noise helps improve focus, boosts productivity, and enhances overall well-being.



POLYESTER FIBRE ACOUSTIC FELT PANEL COMPOSITE

Sonofelt Polyester Acoustic Felt is designed to provide maximum decorative design flexibility providing a decorative to the extensive range of DecraSound acoustic products. The Sonofelt acoustic felt when added to acoustic substrates provides both colour and acoustic control and offers the advantage of creating additional pin-able wall space. Sonofelt polyester felt is manufactured from 75% recycled polyester fibre which is non-toxic, odorless, and has low volatile content. Sonofelt complements the existing Sontext range of fabric-faced and perforated timber acoustic panel products, ensuring our clients have maximum choice of acoustic solutions for interior sound control.

Product Specifications

Product	Polyester Fibre acoustic felt				
Material	100% Polyester Fibre				
Thickness(mm)	1	2	3	4	5
Density (g/sqm)	200	400	600	800	1000
Size (m)	1.05*100	1.05*100	1.05*50	1.05*50	1.05*50
Color	48 colors in stock				
Eco-friendly	E0				

Felt colour chart



2 mm



3 mm



FELT PANEL COMPOSITE

POLYESTER FIBRE ACOUSTIC

Our DECRA SOUND felt panels are manufactured from 100% polyester fibre, needle-punched felt and bonded with eco-friendly glue. Installation is straightforward, without requiring extensive wall prep or painting. These panels uniquely enhance any space while transforming your walls into practical acoustic notice boards. The tackable and hook-and-loop receptive surface makes them an ideal choice for commercial offices, libraries, and educational environments, effortlessly adding function and flair.

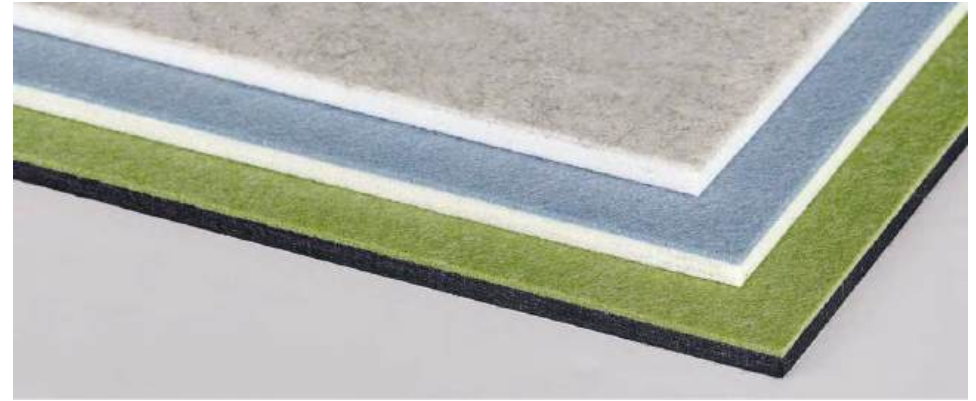

Product Specifications

Product Type	Felt Panel Composite
Size	Max to 2780*1000 mm
Thickness	Felt 2-5mm + Panel 9/12/24mm
Density	1200g/sqm to 4800g/sqm
Color	Felt from DF number, panel from DS number



Carved Feature Acoustic Panel

Transform more than just acoustics with our Decrasound carved feature acoustic panels. These panels go beyond traditional uses, providing a base for creative and aesthetic designs. With their elegant carved design, they unlock endless possibilities in decoration and functionality. Ideal for wall coverings, cabinetry, furniture, and more, these panels are a versatile choice for any setting. Discover the potential to beautify and make your space quieter.

CARVED FEATURED ACOUSTIC PANEL

HOLLOW-OUT ACOUSTIC PANEL

DECRASOUND Hollow-out acoustic panels allow the designer to develop their style with the latest technological innovations. These panels enhance the aesthetic appeal of any space and create a modern feel. Hollow-cut acoustic panels also create privacy in open areas as screens between work areas. They are perfect for workplaces that value style, creativity, and function.

Product Specifications

Product Type	Hollow-Out Acoustic Panel
Material	100% Polyester Fibre
Size	2400*1200mm/2780*1200mm / customized
Thickness	9 mm/12 mm/24mm
Density	2000g/sqm ; 2400g/sqm ; 3800g/sqm
Color	96 colors
NRC	0.45-0.9



More Patterns

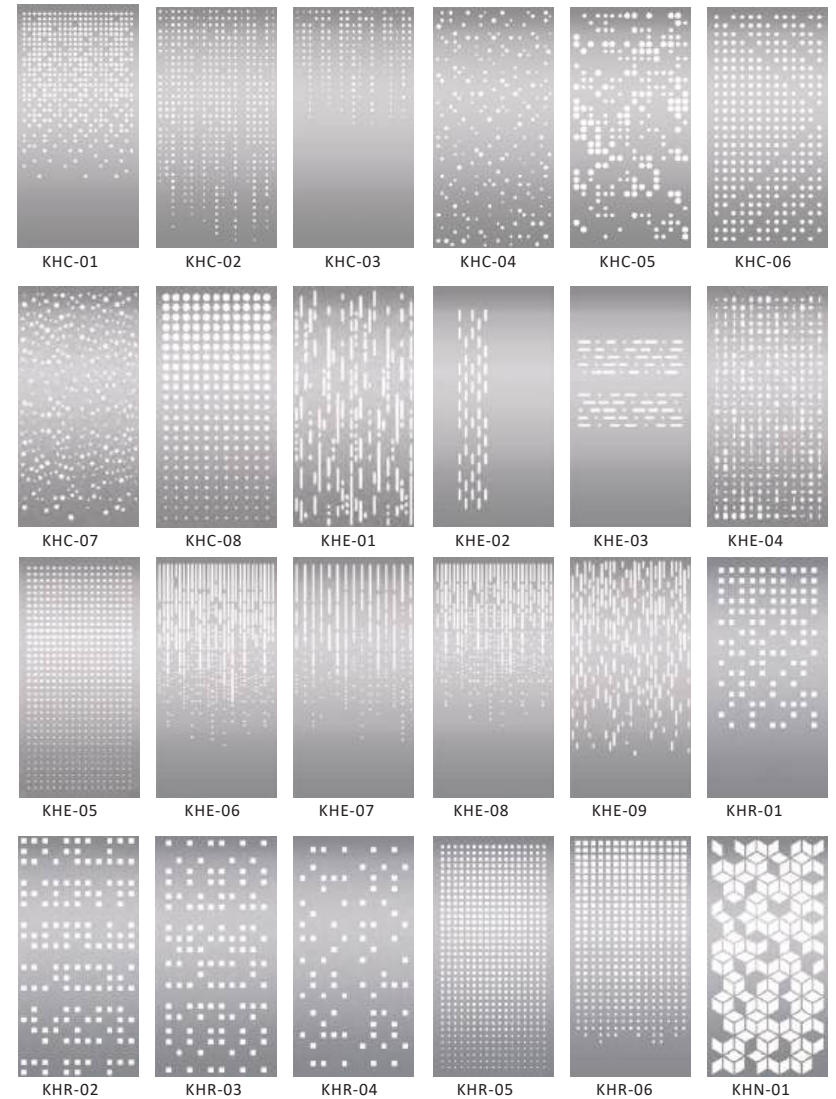

Customized designs available

More Patterns

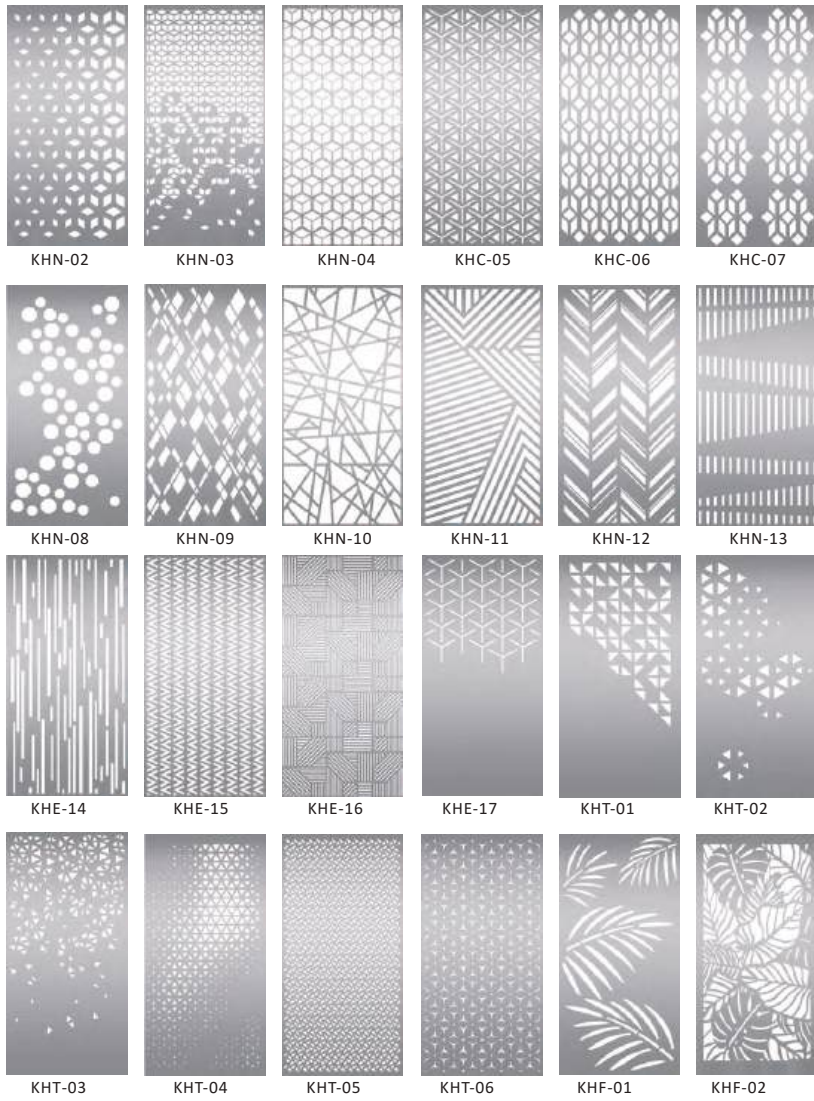

Customized designs available

More Patterns

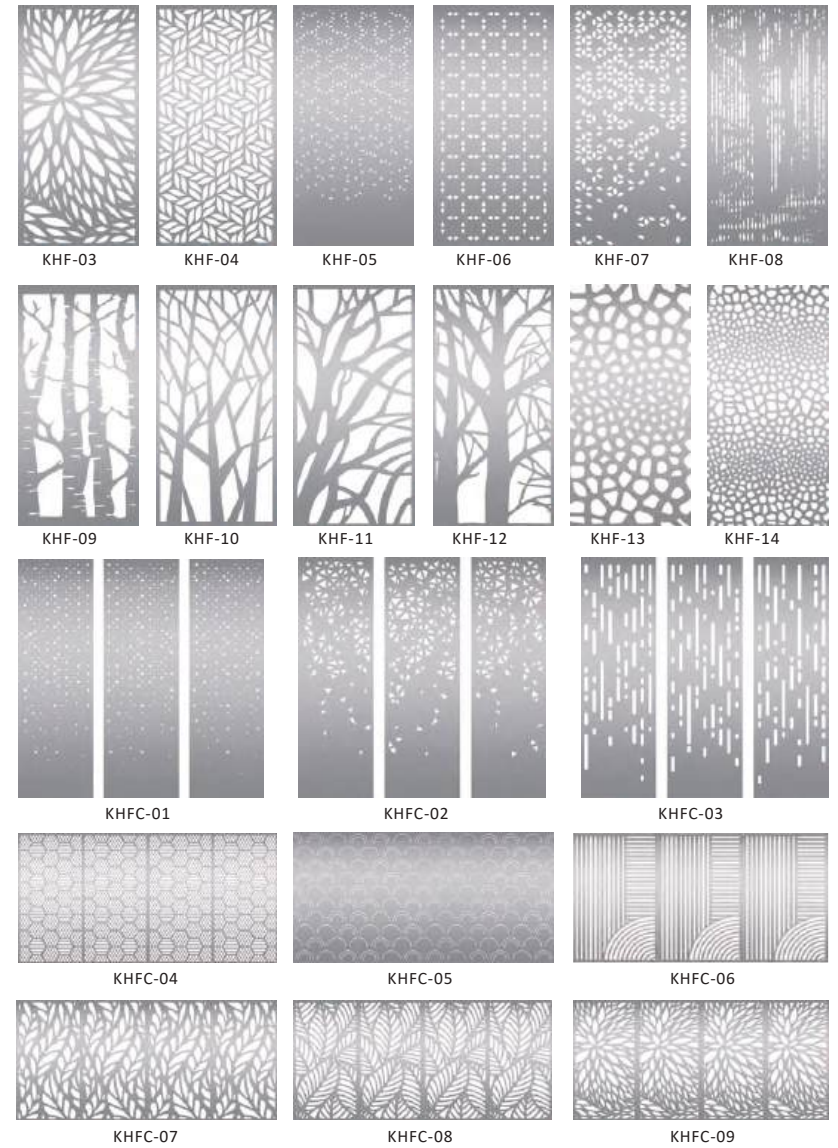

Customized designs available

CARVED FEATURE ACOUSTIC PANEL

V-GROOVED ACOUSTIC PANEL



Product Specifications

Product Type	V-grooved Acoustic Panel
Material	100% Polyester Fibre
Size	2400*1200mm / 2780*1200mm / customized
Thickness	9mm / 12mm / 24mm
Density	2000g/sqm ; 2400g/sqm ; 3800g/sqm
Color	96 colors
NRC	0.45-0.9

V-Groove recommend

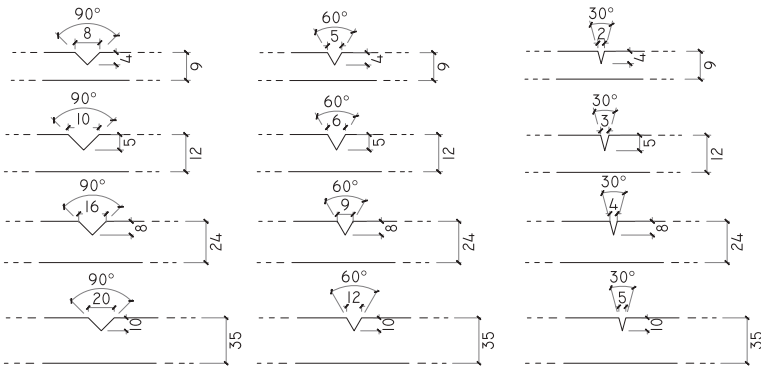

For 90 degree V-groove depth available from 2mm to 24mm.
 For 30 and 60 degree V-groove depth available from 2mm to 15mm.

More Patterns

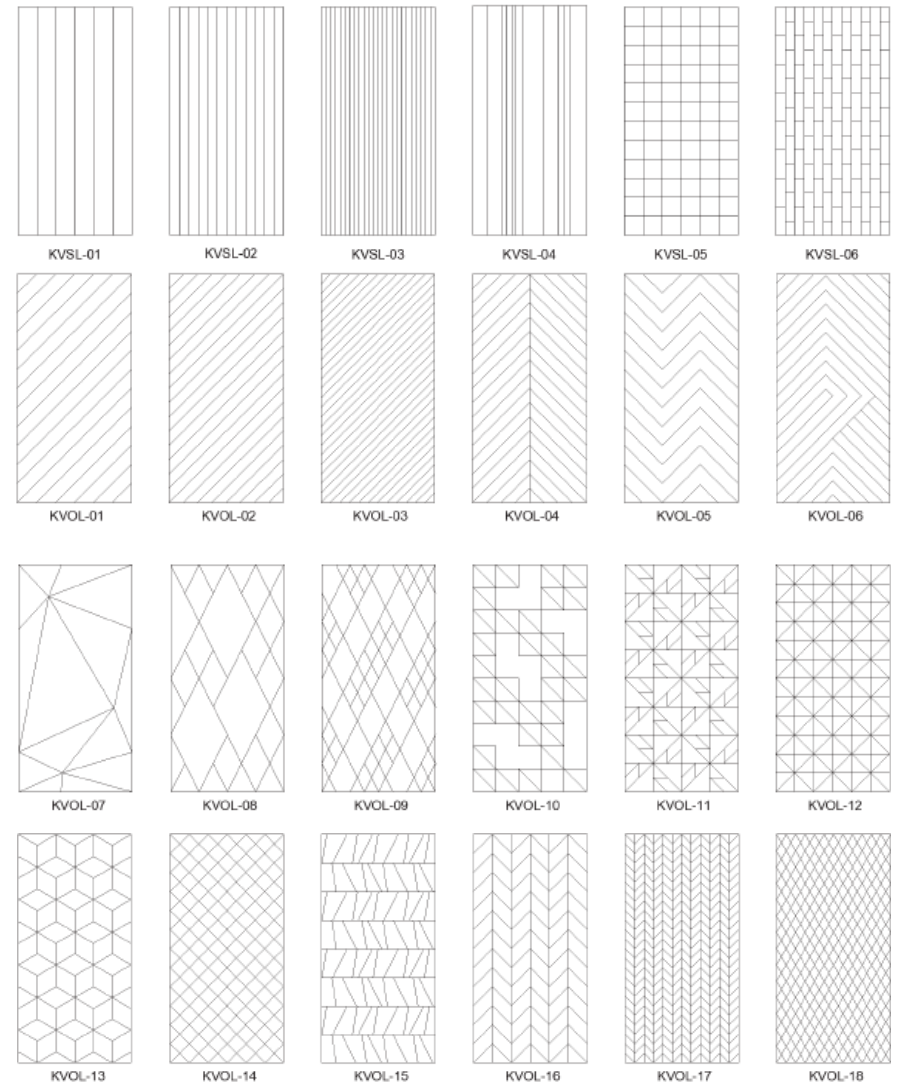

Customized designs available

More Patterns

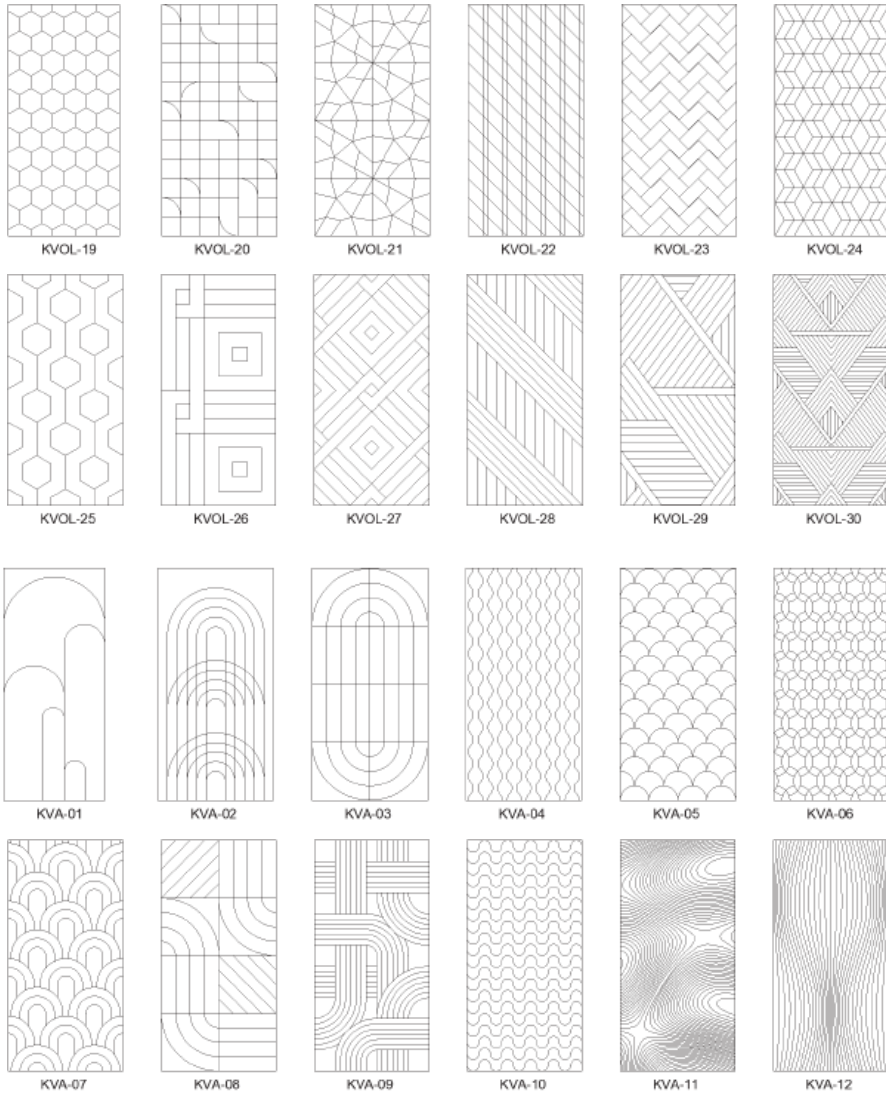

Customized designs available

Free Combination

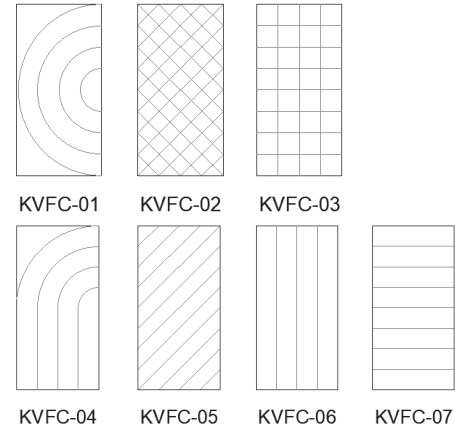

CARVED FEATURE ACOUSTIC PANEL

3D VISUAL U GROOVED ACOUSTIC PANELS

Change Up Your Space with Stylish Design. Decrasound carved panels are available in traditional v grooves. With the introduction of U-grooving, we now offer an exciting way to mix up your wall decorative treatments.

Product Specifications

Product Type	3D Visual U-grooved Acoustic Panels
Material	100% Polyester Fibre
Size	2400*1200mm / 2780*1200mm / customized
Thickness	9mm/12mm/18mm/21mm/24mm
Density	2000g/sqm ; 2400g/sqm ; 3800g/sqm
Color	96 colors
NRC	0.8-0.9

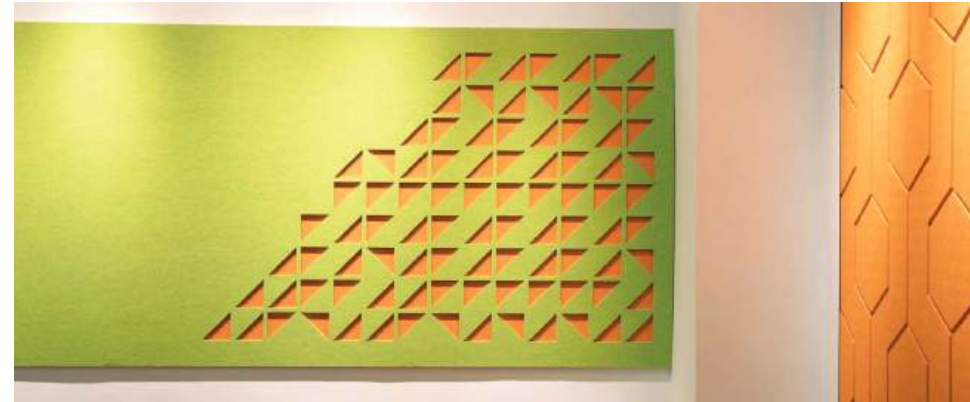

DECRASOUND provides different cutting styles to get your creative ideas flowing, making these panels great for all commercial buildings and purposes. Our design team has designed eye-catching 3D U-grooved panels with sleek curves, fun shapes, and clean lines. These panels bring something new and exciting to the market and challenge traditional concepts. Check out these unique panels in our product catalogue and give your space a modern twist!

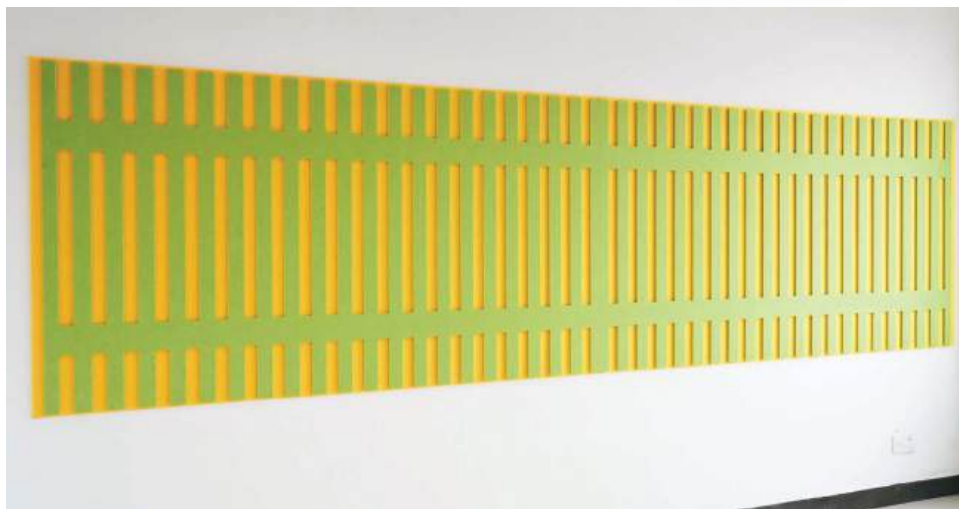

CARVED FEATURE ACOUSTIC PANEL

Tear Drop ACOUSTIC WALL PANEL

Inspired by the visual of falling teardrops, our TearDrop Design Panels feature a dynamic pattern of lines that stand out from the usual. You can pick up to two colours from our DECASOUND colour range to make a unique statement. These panels don't just look good; they are manufactured from layered felt that's thin, light, and moisture resistant. Durable and stylish, Teardrops panels are designed to make your space more comfortable from noise and have an exciting, fresh, modern look. Check them out in our product catalogue and add flair to your walls!

Product Specifications

Product Type	TearDrop Acoustic Wall Panel
Material	100% Polyester Fibre
Size	2400*1200mm / 2780*1200mm / customized
Thickness	9mm / 12mm / 24mm
Density	2000g/sqm ; 2400g/sqm ; 3800g/sqm
Color	96 colors
NRC	0.45-0.9



More Designs

Rainbow Balloon

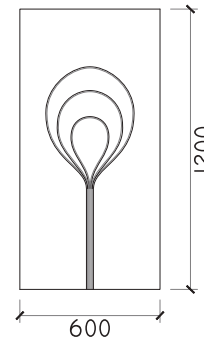

Retro Lantern

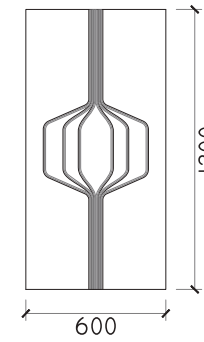

Vertical Star

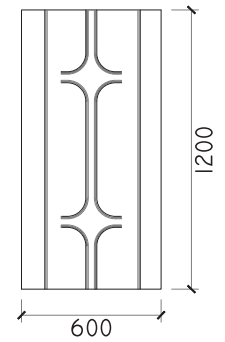

Rain Line

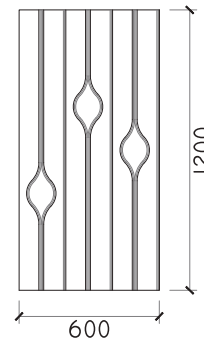

Flat Cylinder

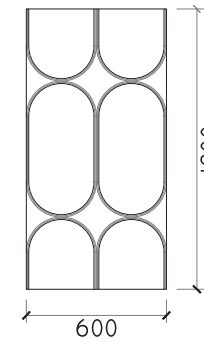

Arched Door

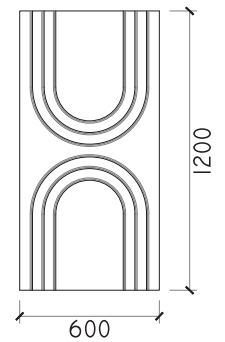

Garden Fence

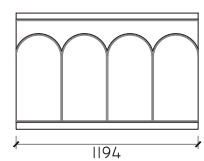

Horizontal Star

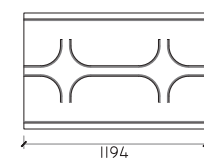

Raindrop Petal

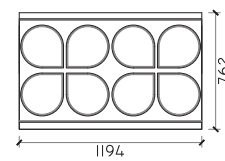

Divergent Square

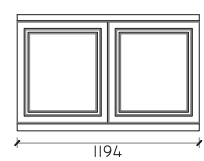

Simple Vertical

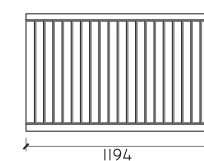

Dense Vertical

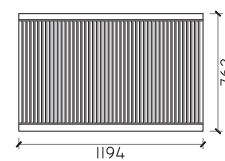



PRINTED POLYESTER FIBRE ACOUSTIC PANEL

Check Out Our DECRASOUND Printed Panels.

Are you looking for something hard-wearing, stylish, and recyclable? Our DECRASOUND printed polyester fibre acoustic panels are made to last, are impact resistant, and are moisture resistant. Decrasound Printed Panels are printed with water-based, odorless ink that keeps colours sharp and doesn't fade. Plus, you can wash or wipe them without worry.

These panels aren't just functional; they also come with exciting digital patterns that make any commercial space look great! They help manage noise and create a remarkable visual effect. Want something uniquely yours? You can customize them with your own patterns, too. Look at our catalogue and find the perfect match for your space!

Product Specifications

Product Type	Printing Wall Covering
Material	100% Polyester Fibre
Size	2400*1200mm/2780*1200mm / customized
Thickness	9mm / 12mm / 24mm
Density	2000g/sqm ; 2400g/sqm ; 3800g/sqm
NRC	0.45-0.9
Eco-friendly	E0

Wooden Grain



Stone and Brick

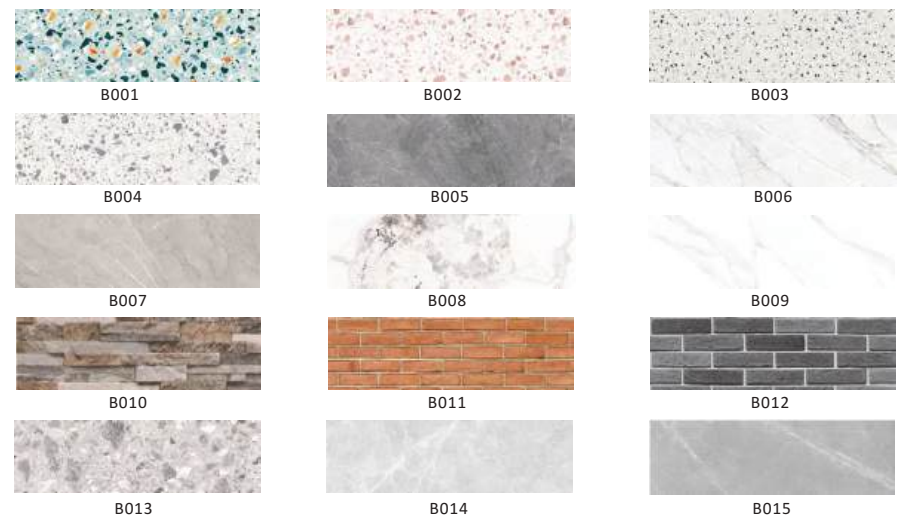



3D Polyester Acoustic Panels

Check Out Our Decrasound 3D Modular Panels. Are You looking to update your space with a fresh, modern style while keeping things quiet? Our Decrasound 3D modular acoustic panels are just what you need. These panels are light but robust, durable, and very effective at reducing noise. Decrasound 3D Modular Panels are available in many designs, but you are not limited to our design. We can custom design to suit your space and needs. Flip through our catalogue to find out more about these versatile panels!

3D Polyester Fibre Acoustic Panels

Dimension Pyramid

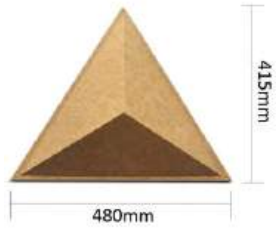

Dimension Spring

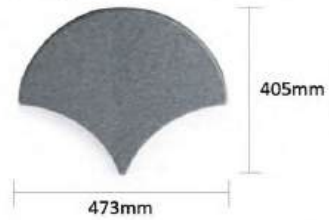

Dimension Hex

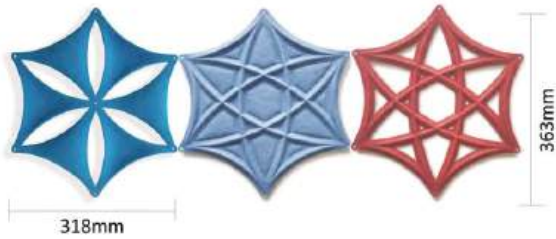

Dimension A

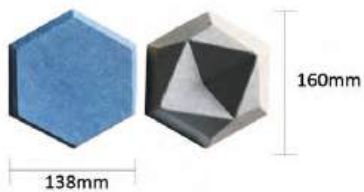

More Designs

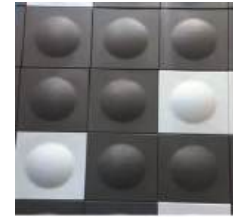

Dimension Dot Mini
600*600*60mm

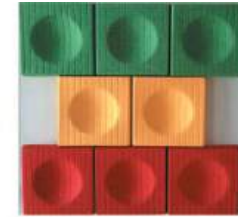

Dimension Bowl
600*600*65mm



Dimension Triangle
585*585*60mm



Dimension Lines
820*820*32mm



3D Line 45
600*600*45mm

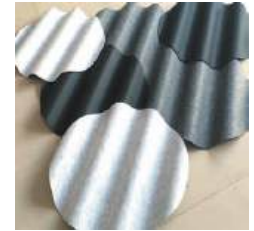

Dimension Corrugated
740*750*76mm



3D ST Line
600x600x45mm

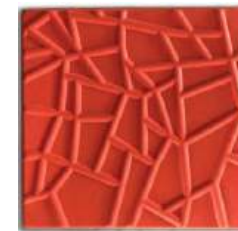

3D Twigs
500x500x25mm



Dimension Diamond
300*300*85mm



Dimension Small Circles
300x300x38mm

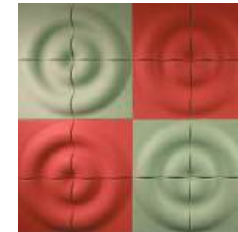

Dimension Circles
600*600*68mm



Dimension Hex Large
960x831x128mm

96 colors available



Acoustic Office Furniture

Explore Decrasound Acoustic Furniture

Designers and architects widely choose Decrasound acoustic furniture for global projects. Our office furniture is practical and environmentally friendly, has a sleek look, and is available in various solid colours. Specifically designed to absorb and diminish unwanted noise in commercial areas, our vertical screens are an excellent choice. They are placed near the noise source and blend seamlessly with current office aesthetics. Decrasound Acoustic Office Furniture is ideal for improving your space's quietness and style. Please browse our selection and discover how our furniture can transform your environment!

ACOUSTIC OFFICE FURNITURE DESK DIVIDER



DECRApanel

Size
2400*400*12mm
1200*400*12mm
1200*600*12mm
or customize

Finishes
Kingkus® Standard
Panel

Mounting
Desk mounted with
clips or hangers



DECRCARVED

Size
2400*400*12mm
1200*400*12mm
1200*600*12mm
or customize

Finishes
Kingkus® Standard
Panel or felt

Mounting
Desk mounted with
clips or hangers



DECRAFOLD

Size
2400*400*12mm
2000*400*12mm
1800*400*12mm
or customize

Finishes
Kingkus® Standard
Panel

Mounting
Desk mounted with
clips or hangers



DECRAinsert

Size
800*600*12mm
800*700*12mm
or customize

Finishes
Kingkus® Standard
Panel

Mounting
Insert directly on the
desk



DECRAprotrusion

Size 尺寸
1400*560*18 mm
1160*450*18 mm
1160*500*18 mm
1160*550*18 mm
or customize

Finishes
Kingkus® Standard
Panel

Mounting
Insert directly on the
desk

More Designs



ACOUSTIC OFFICE FURNITURE

Girando DIVIDER

The Girando collection from DECRASOUND includes sound-absorbing panels that help create private spaces while keeping you connected to the surrounding area. These panels are part of a self-standing unit, and each one can be turned independently. Girando collection allows users to adjust the panels to either open or close off their space as needed, giving them control over how much privacy and sound control they want.

The Girando Divider is great for setting up private or semi-private areas without making you feel completely cut off. It helps manage a space's appearance and sounds, making it more comfortable.

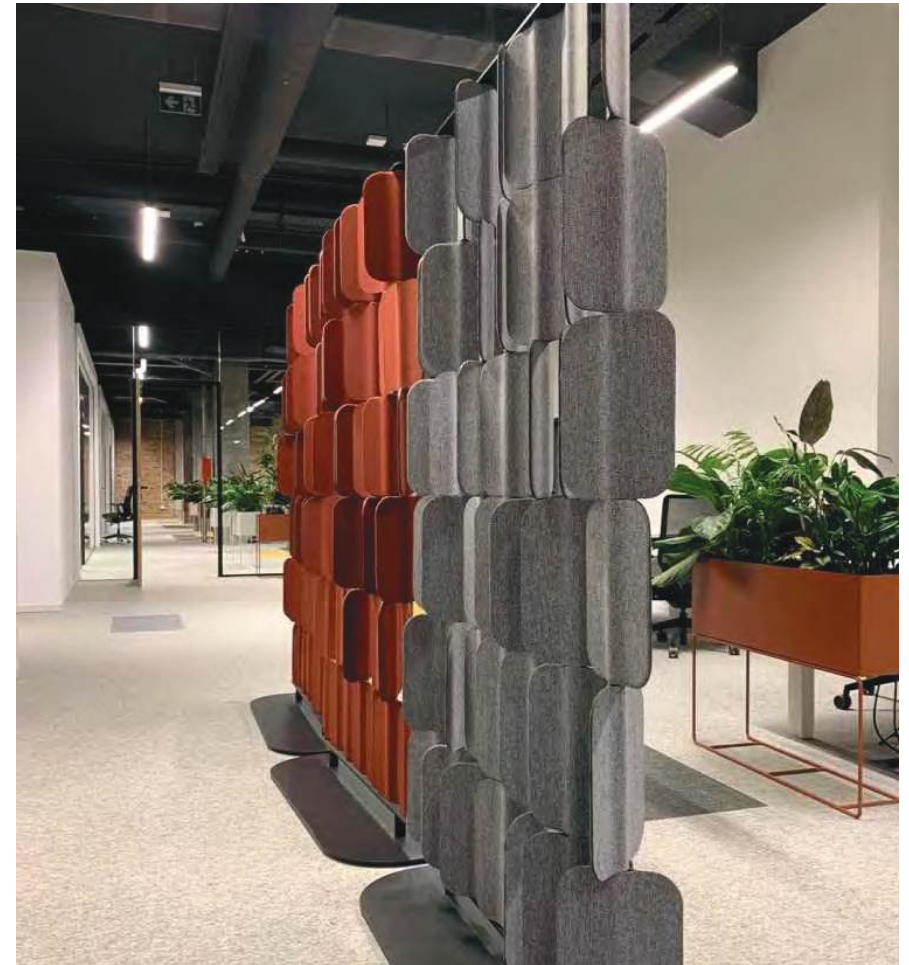
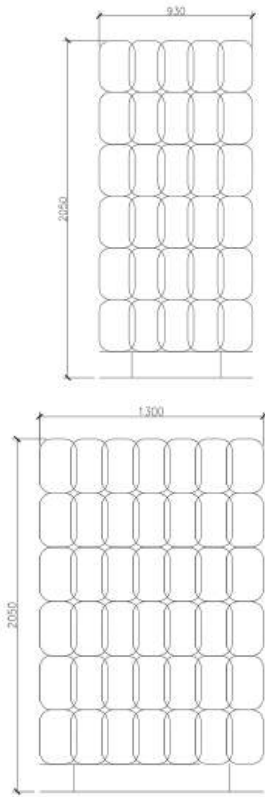

DECRASOUND's Girando dividers are designed to make organizing space straightforward, cost-effective, and attractive. This flexibility means you can quickly define and redefine spaces as required.

ACOUSTIC OFFICE FURNITURE

DECRASOUND free-standing divider for your office space.

Decrasound Free-standing acoustic screens are free-standing, modular room dividers easily arranged into privacy screens, displays, or even temporary walls and rooms. We offer these dividers in various styles and shapes to fit both enclosed and open areas, making them ideal for creating private spaces or visually separating different sections of your office. This flexibility helps you manage your office layout more effectively.

Size
1180*1810 mm
1200*1500 mm
1560*1210 mm

Material
Acoustiscreen Wall Panels

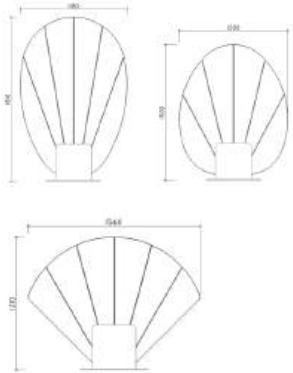

Size
500*300 mm
540*300 mm

Material
Acoustiscreen Wall Panels

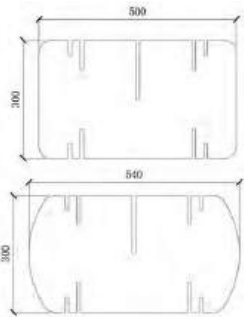

Size
1200*1800 mm

Material
Kingkus* standard panel

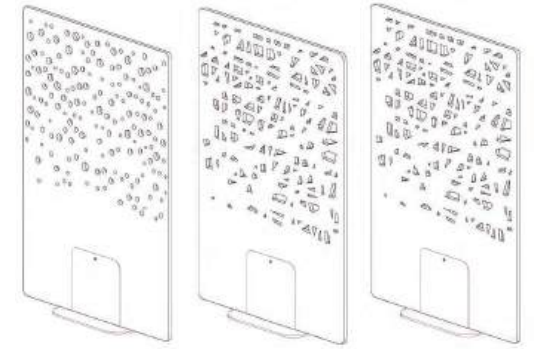
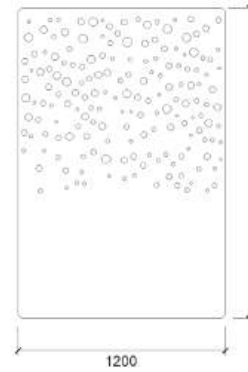

DECRASOUND APPLICATIONS

Sontext® designs acoustic products to meet the growing need for functionality in commercial spaces while reducing noise. As a result, our designers have developed a range of wall, ceiling, and lighting options that provide excellent noise reduction and look great. These products are suitable for offices, schools, and other buildings where comfort from reduced noise levels is important. Meanwhile, Sontext® remains committed to its core principles of ecological responsibility, design flexibility, and superior acoustic performance in all our products.

DECRAWAVES ACOUSTIC PANEL

Decrawave panels help manage sound in your office while adding a creative aesthetic appeal. These sound-absorbing panels feature a simple wave pattern that you can mix and match to create different wall or ceiling patterns. Decrawave is available in various colours and can be installed at various angles, allowing you to customize the look and feel of your office space to fit your needs.



DWave A
2400*1200*8mm/11mm
2760*1066*8mm/11mm

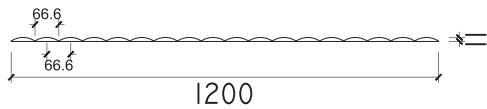

DWave B
2400*820*38mm
2760*820*38mm

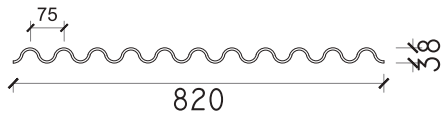

DWave C
2400*1150*20mm
2760*1050*20mm

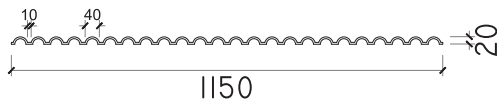

DWave D
2400*1120*26mm
2760*1020*26mm

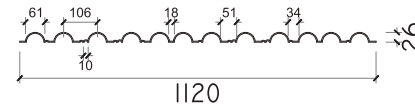

DWave E
2400*1050*27mm
2760*950*27mm



DWave F
2400*1200*12mm
2760*1100*12mm

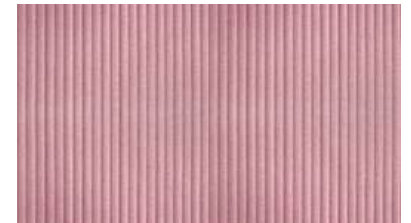
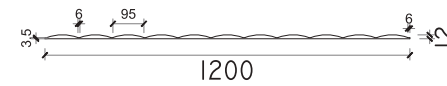

DWave G
2400*1200*10mm
2760*1100*10mm

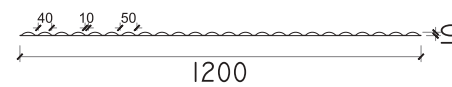

DWave H
2400*1080*30mm
2760*1020*30mm

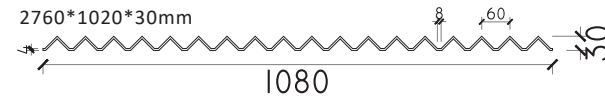

DWave S
2400*1200*10mm
2760*1120*10mm

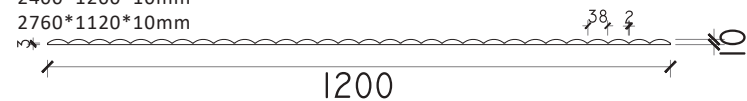

DECRASLAT ACOUSTIC PANEL

The DECRASLAT acoustic panel improves sound absorption in your space, making it quieter and more comfortable for everyone. This panel also adds a modern look with its various surface options, including melamine and wood veneer, making it a good fit for offices, retail spaces, and restaurants. DECRASLAT will decrease noise levels and minimize echo. It is a practical solution for managing sound in commercial settings.



Product Specifications

Product Type	DECRASLAT
Material	MDF board & PET fiber
Finish	Melamine/HPL/wood veneer
Size	2400*600*22mm/2780*600*22mm/customized
NRC	0.45-0.9

Advantages

- Effective Noise Reduction**
 Sound-absorbing Decrafelt helps reduce noise and lessen annoying echoes in your space, making your office quieter and more comfortable.
- Rich in Colour and shape**
 Our acoustic panels are available in various wood grain colours and finishes, providing options that complement any commercial decor. This makes it easier to find a style that fits seamlessly into your space.
- Flame Retardant**
 The black acoustic felt meets all international fire standards.

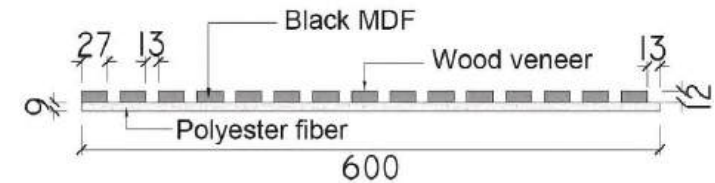

Wood Veneer Recommend

WV113 White Oak-1	WV228 White Oak-2	WV342 Silvery Thread	WV202 Silver Pear	WV359 Boxwood	WV224 White Rattan	WV336 Pearwood	WV201 Cassia Siamea
WV265 Walnut-1	WV252 Walnut-2	WV315 Walnut-3	WV316 Walnut-4	WV209 Ebony-1	WV262 Ebony-2	WV261 Ebony-3	WV230 Ebony-4



ACOUSTIC WALL

DECRAWall is a modular acoustic tiling system that can be arranged in numerous ways to create custom wall designs. You can create various patterns and shapes to suit the style and requirements of any room. This flexible system enables you to customize the look of your space while improving the acoustics.

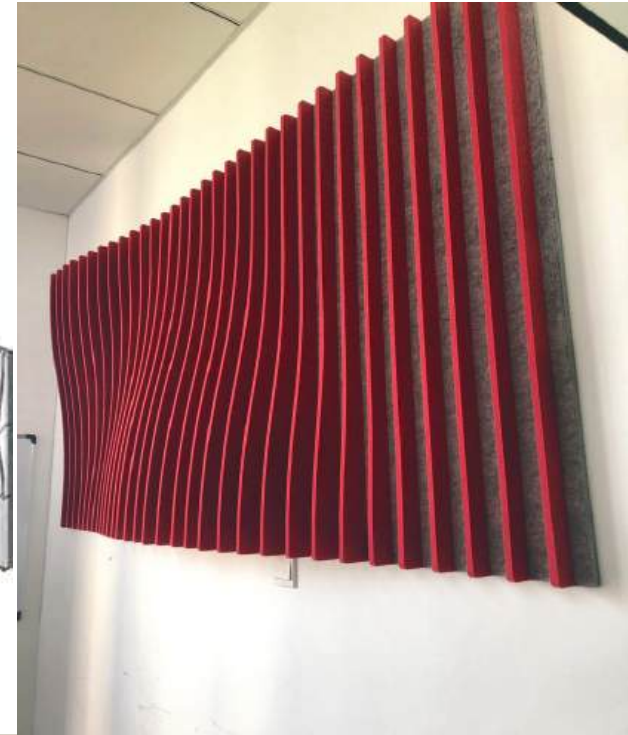
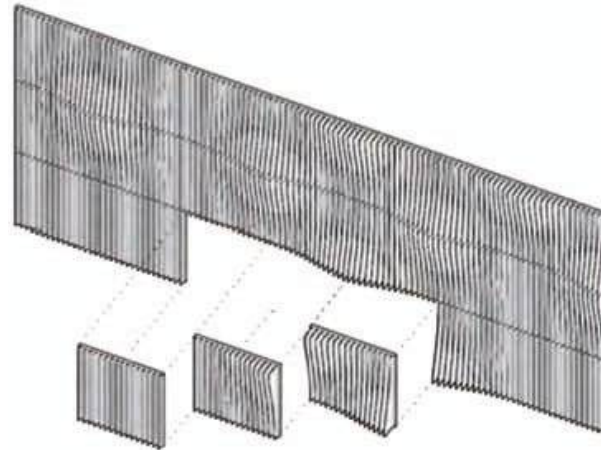
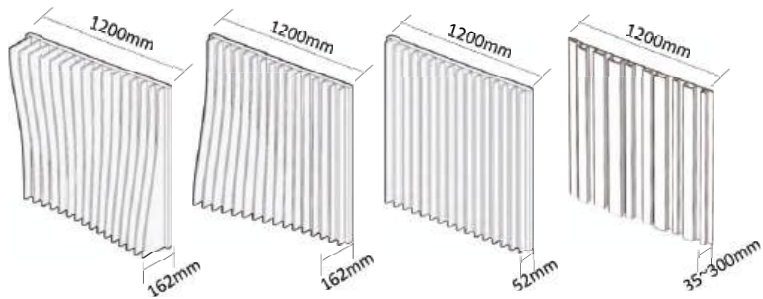

CEILING SYSTEM

DECRA U-TECHCEILING

Our modular polyester fibre acoustic panel ceiling system has excellent sound-absorbing properties and a distinctive look. It's designed to be visually and acoustically pleasing, with a strong focus on sustainability. We customize the sizes to fit your specific space perfectly. This system is an effective and attractive way to manage sound in your office.

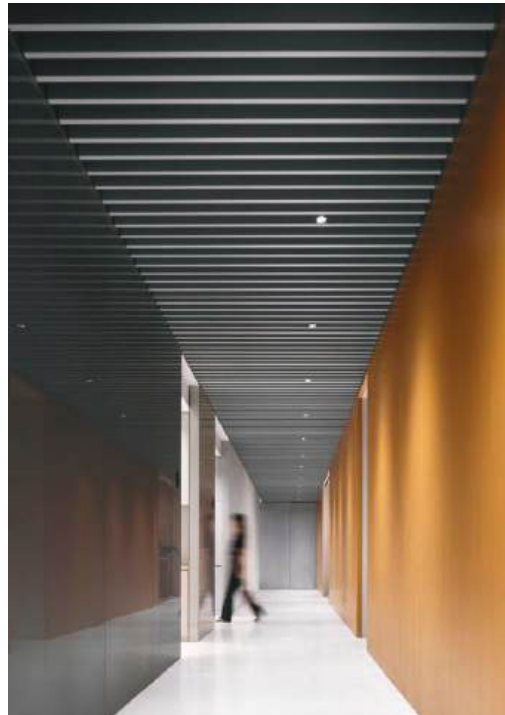
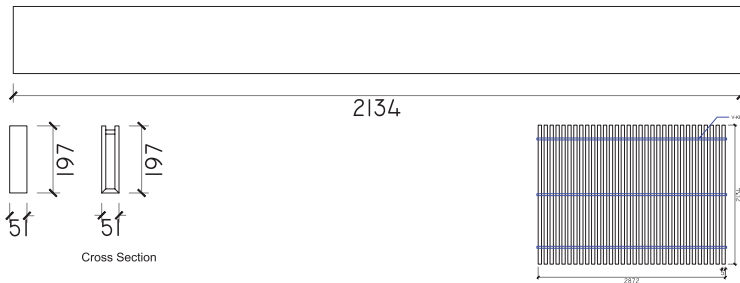

CEILING SYSTEM DECRATUBE

DECRATUBE offers a unique design that's perfect for large open spaces. It comes in more than 95 colour options, making it effective in managing sound and visually appealing for large areas and individual installations. This product can help you tackle noise issues while adding a unique and attractive ceiling system.

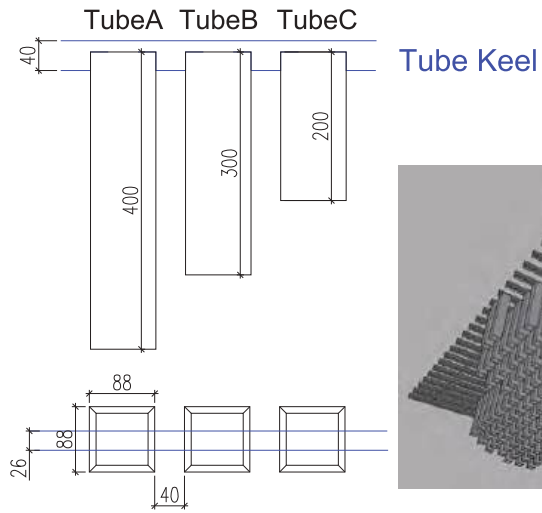
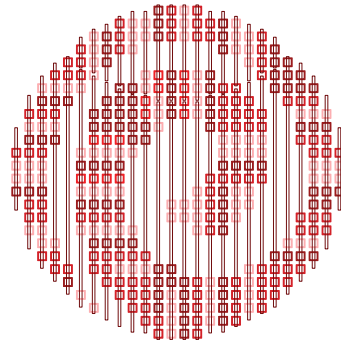

CEILING SYSTEM

DECRASTAR



The 3D DECRASTAR ceiling system allows you to reflect your design preferences while improving communication in the space. The diamond-shaped facets help to scatter sound waves, and the DECRASOUND acoustic panel surface absorbs sound. Decrastar ceiling systems reduce echoes and help control noise, making it easier for everyone to talk and work without disruptive sounds.



More Designs

DECRASTAR A



915mm(L)X792mm(W)X140mm(H)
1200mm(L)X1039mm(W)X183mm(H)
1760mm(L)X1524mm(W)X269mm(H)

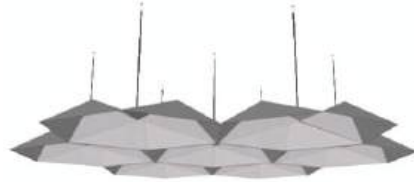

DECRASTAR B

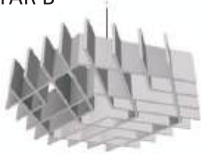

914mm(L)X792mm(W)X140mm(H)
1200mm(L)X1039mm(W)X140mm(H)

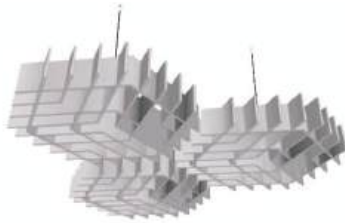

DECRASTAR C



914mm(L)X792mm(W)X140mm(H)
1755mm(L)X1520mm(W)X140mm(H)

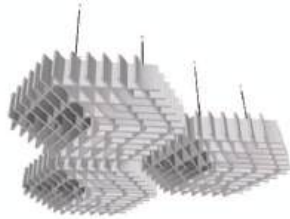

DECRASTAR D



969mm(L)X897mm(W)X150mm(H)
1933mm(L)X1820mm(W)X150mm(H)
2535mm(L)X2350mm(W)X150mm(H)



More Designs

DECRASTAR E



914mm(L)X792mm(W)X140mm(H)
1200mm(L)X1039mm(W)X140mm(H)
1760mm(L)X1524mm(W)X140mm(H)

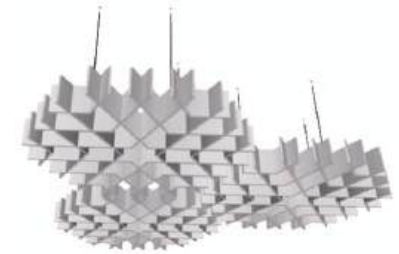

DECRASTAR F

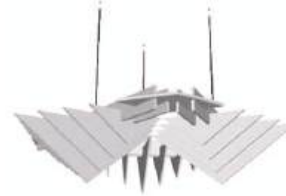

1438mm(L)X1245mm(W)X265mm(H)



DECRATriangle



900mm(L)X779mm(W)X190mm(H)



CEILING SYSTEMS

DECRABAFFLE

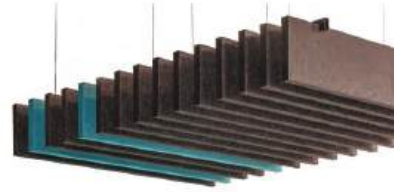

Acoustic baffles are panels suspended vertically in spaces with high ceilings or only a roof line. DECRAbaffles are available in several arrays and can be manufactured to suit small or larger spaces such as auditoriums. DECRAbaffles have been tested for their acoustic performance against all international standards, yielding excellent results in several configurations. DECRAbaffles are compatible with standard connection systems, allowing for quick and easy installation. This system combines appealing design with effective sound management, making it a practical choice for enhancing workplace environments.

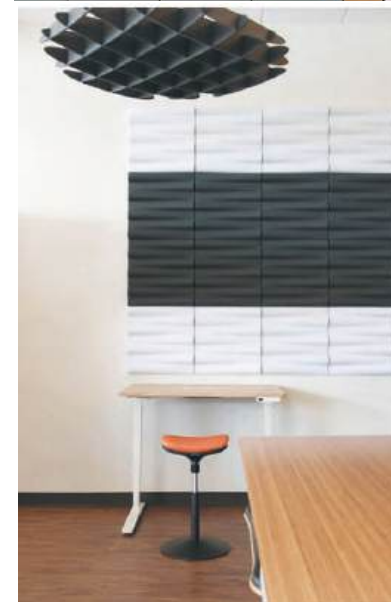

CONTACT INFORMATION

Head Office, Australia
47 Longford Road,
Epping, Victoria, Australia 3076
T: +61 3 9432 2733
E: sales@sontext.com.au

Middle East Office
Level 23, Boulevard Plaza 2
Downtown Dubai—UAE
T: +971 4 409 6863
E: uae@sontext.com.au

USA Office
Bartley Group
27071 Cabot Road,
Suite 125 Laguna Hills,
CA 92653 USA
T:+1 949 215 7979
E:info@bartleygroup.com